

NOW... YES,
NOW IT is technically
and economically
POSSIBLE!



**DARKSKY
APPROVED**
Reduces light pollution
Certified by DarkSky.org

Helping from now ON, with:

Sta®LED Darksky





New LED Lighting Solution

PEDESTRIAN AREAS | RURAL ROADS | BIKE LANES
BEACHES | SPORT AREAS | RESIDENTIAL AREAS...

Sta[®]LED Darksky Th02

Solar Post Top Light



UNIQUE INNOVATIONS © WWW.SMART-CITY-SOLAR.COM

WORLDWIDE[®]

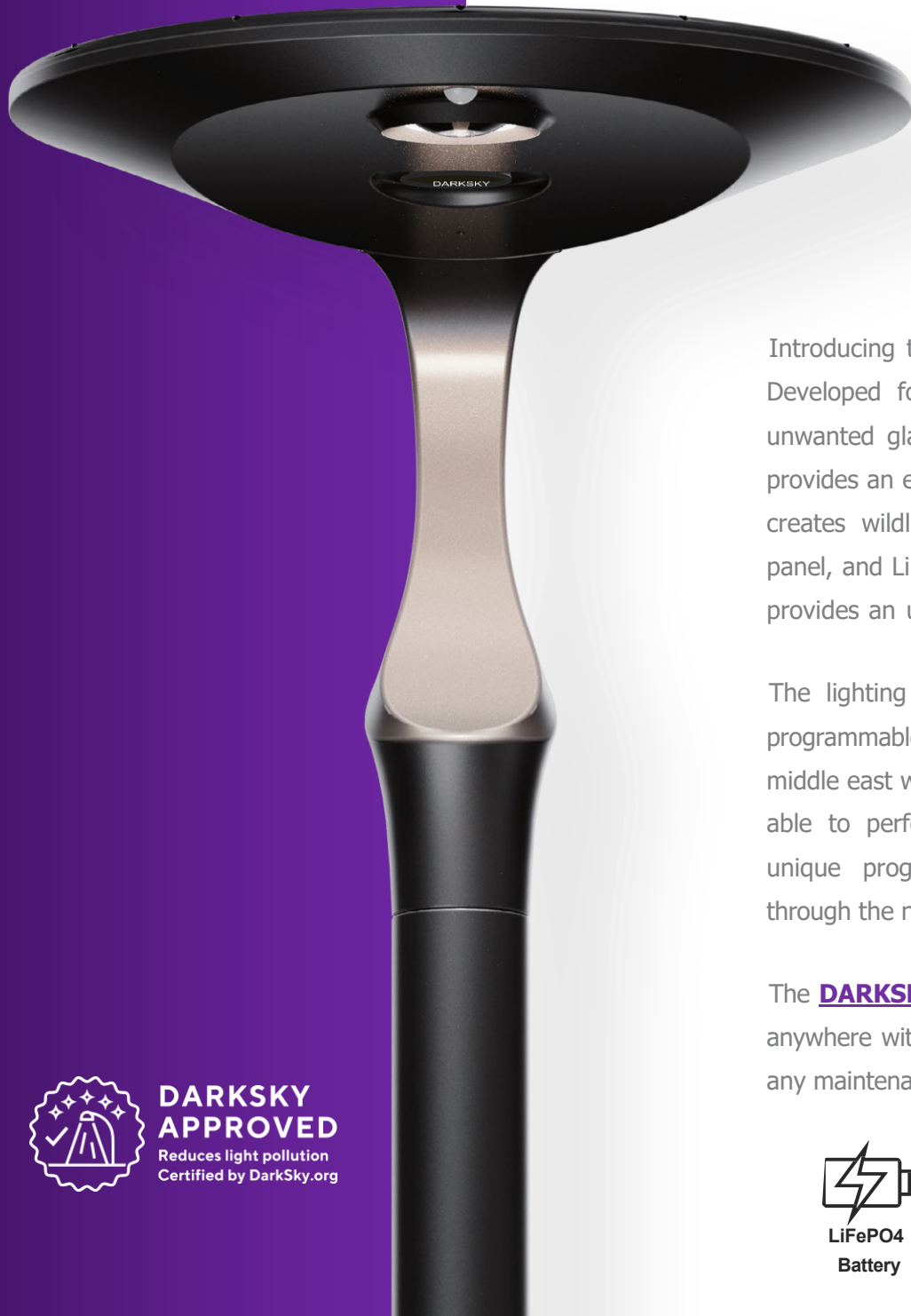

It's in our hands to improve everything possible!

Introducing the **DARKSKY-TH02** solar post top light, offering a new and futuristic design. Developed for our environment to protect native animals from blue-light harm and the unwanted glare of led lights. With a UWLR of <math><1\%</math> of the lighting distribution, the fitting provides an even lighting performance without light pollution. Simply put, **DARKSKY-TH02** creates wildlife-friendly lighting for our environment. The combination of a MONO solar panel, and LiFePO4 battery, and a high-charging efficiency 96% MPPT solar charge controller provides an ultra-bright output of 190lm/W with the lowest lighting power setting.

The lighting output power and working period as well as color temperature are client-programmable to ensure the fitting will perform well to your satisfaction. No matter in the middle east with plenty of sunshine or in north Europe with less sunshine, **DARKSKY-TH02** is able to perform well with constant lighting brightness and sufficient time. The custom unique programming of **DARKSKY-TH02** will ensure stable, continuous illumination through the night through all seasons.

The **DARKSKY-TH02** is popular for gardens, parks, walk paths, and bicycle lanes to light up anywhere with the best lighting performance. The designed lifetime is up to 10 years without any maintenance.



**DARKSKY
APPROVED**
Reduces light pollution
Certified by DarkSky.org



LiFePO4
Battery



Intelligent
Control



High brightness
LED beads



Biodiversity
Protection



IP65
Waterproof



Designed
Aesthetically



Remote
Control

TECHNICAL DATA:

Lighting Performance

Item number	DARKSKY TH02
Luminous flux	2,800lm max
Peak LED power	18W
CRI	>80
LED type	SMD2835 84pcs
CCT range (dual color)	2200K+3000K / 3000K
LED lifetime	>100,000 hours
Certificates	CB CE ROHS IP65 LM79 LM80, MSDS UN3.8
Light dimension	φ590 * H550mm
Materials	Aluminium die casting + tempered glass
Fixture color	Black RAL9011 / Anthracite grey RAL 7016

LiFePO4 Battery

Battery type	Brand new LifePO4 32700 6000mA 3.2V
Battery capacity	154WH 12.8V
Battery lifetime	6000 cycles @ D.O.D 80%
Charge Time	4 hours
Discharge time	>24 hours
Working temp.	-15 C ~ 70 C
Battery autonomy	2 - 3 days, 3~5 days in motion detection mode

Solar Panel

Peak Power	38W
Rated Voltage	18V
Cell Type	MONO crystallinesilicion
Cell Efficiency (%)	>22.5%
Lifetime	>20 years

Remark:

CCT of >3000 (lower) is required for IDA certification compliance.

Control System

Control method	Automatic dusk to dawn
Solar charge controller	MPPT controller
Charging efficiency	>97%
Remote type	2.4G radio
Operation distance	up to 30 meters
Sensor type	PIR motion sensor
Grouping function	Yes
CCT changeable	Yes
LED power changeable	Yes
Time changeable	Yes
Working mode changeable	Yes



Key Components



Dimensions – mm:

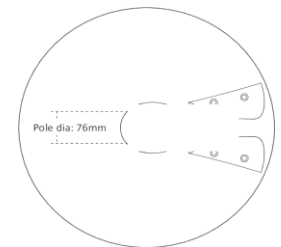
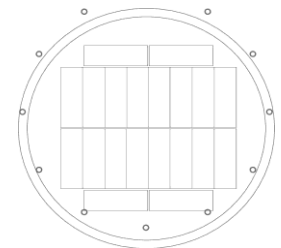
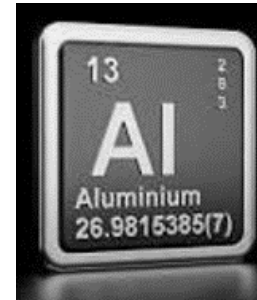
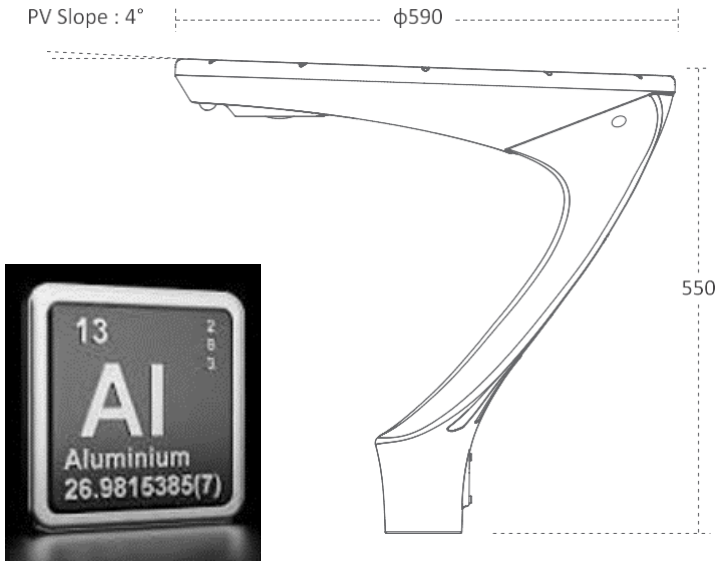

Color Palette for aluminium Poles

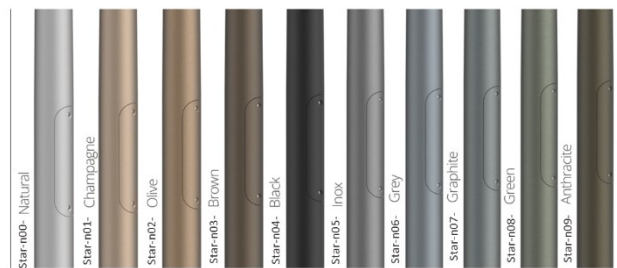

Lighting Performance

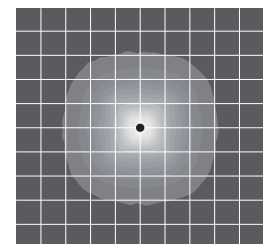
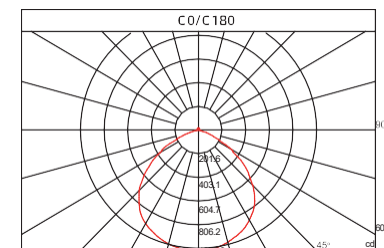

Product Feature



Wild animals friendly
without lighting pollution



MATCH

Lights can be grouped
by remote control



2.4G remote signals is
more stable performance



4H / 6H / 12H optional
changeable by remote



Green energy from the sun
never pay electricity bill



Dual CCT is changeable
between two colors.



6000 cycles brand new
LifePO4 battery unit



Sensitive PIR motion
sensor can be ON/OFF



ON - OFF

Dusk to Dawn
automatically ON/OFF



**WITH TWO ADDED ADVANTAGES: NO MONTHLY FEES/COSTS
AND IN CASE OF BLACKOUT = ALWAYS WORKING ON LIGHT**



A cutting-edge all-in-one, turnkey technological system:



Aluminium Pole
5 meter x 3 mm



Lighting Performance

Luminous flux	2,800lm max
Peak LED power	18W
CRI	>80
CCT range (dual color)	2200K+3000K / 3000-4000
LED lifetime	>100,000 hours
Light dimension	φ 590 *H550mm
Warranty	5 years



LiFePO4 Battery

Battery type	LiFePO4 32700 6000mA 3.2V
Battery capacity	154WH 12.8V
Battery lifetime	6000 cycles @ D.O.D 80%
Charge Time	4 hours
Discharge time	>24 hours
Working temp.	-15°C~70°C
Battery autonomy	2 -3 days, 3~5 days in motion detection mode



Control System

Control method	Automatic dusk to dawn
Solar charge controller	MPPT controller
Charging efficiency	>97%
Remote type	2.4G radio
Operation distance	up to 30 meters
Sensor type	PIR motion sensor
Adjustable function	CCT / LED power / Time / Working mode

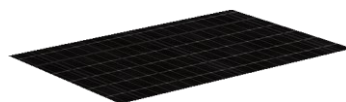

Solar Panel

Peak Power	38W
Rated Voltage	18V
Cell Type	MONO crystallinesilicion
Cell Efficiency (%)	>22.5%
Lifetime	>20 years
Waranty	5 years



An unbeatable option/solution in terms of advantages and PRICE!



More arguments here:

The [DARKSKY-TH02](#) solar street light is a smart LED street light with a monocrystalline solar panel and integrated LiFePO4 lithium battery: adjustable by remote control, including intensity, Kelvin color temperature, motion detection function, and on-time. At a maximum power of 18W, this street light emits up to 2800 lumens, thanks to its SMD3030 CRI LED chips.

The latest lithium battery meets 6,000 DOT 80% cycles, meaning a lifespan of even more than 10 years. [DARKSKY-TH02](#) not only protects the environment with zero energy consumption and CO² emissions, but with a UWLR of <1%, it is also bird and wildlife friendly and helps preserve dark skies.





The **[DARKSKY-TH02](#)** features a dual color system and a Kelvin temperature that can be changed by remote control, allowing these luminaires to create different atmospheres, for example, depending on the season or the time of year.



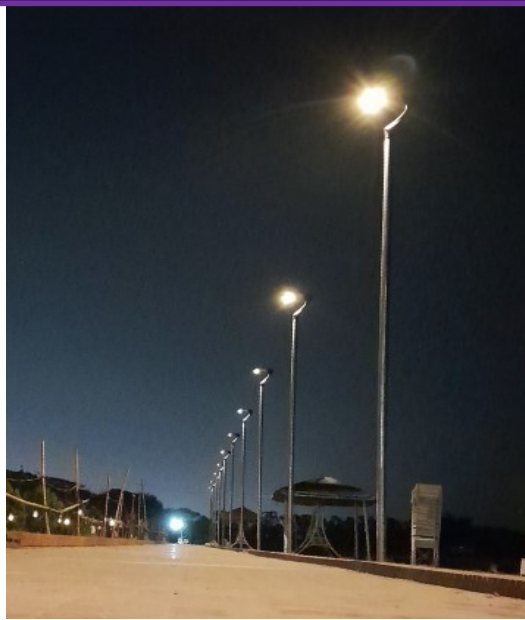

This high quality **TH02** solar lamp post light provides powerful and reliable lighting. A powerful 18W LED lamp provides 2,800 lumens across a wide area. The fixture has an integrated 38W solar panel and large capacity (154WH) lithium battery housed within. The LED color temperature (CCT) can be selected (2,200/3,000k or 5,000k). The light fixture is supplied with a remote control enabling the installer or end-user to select a desired lighting mode. There are several timed modes to choose from as well as dimming and motion detection options. **Color of light fixture and pole is black. IDA Approved and Dark Skies Certified.**

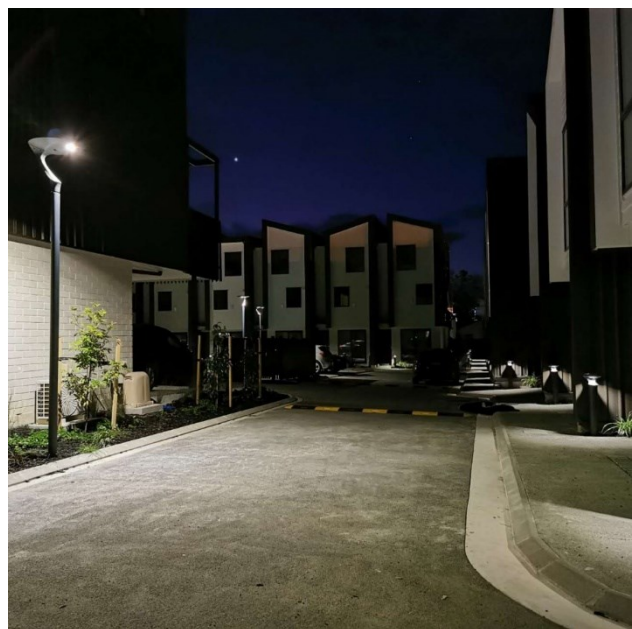
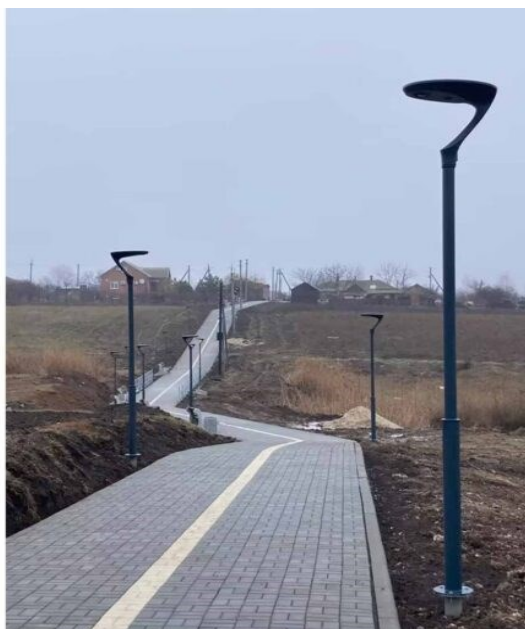

 **DarkSky Approved**
Residential Luminaires

 **DarkSky Approved**
Pedestrian Comfort Luminaires

 **DarkSky Approved**
Commercial Luminaires

 **DarkSky Approved**
Sea Turtle Sensitive Luminaires

Start helping against
LIGHT POLLUTION



The **TH02** is the perfect solution for gardens, parks, walking paths and bike paths, offering the best lighting efficiency and long-lasting operation without the need for mains power.

